

**ETO** GRUPPE  
MOTION TECHNOLOGIES

WORLD  
PREMIERE

THE HEART OF MOTION

We have automated your savings:  
The electrical stoppers from ETO

## About the ETO GRUPPE

The ETO GRUPPE and its more than 2,500 employees are specialists in highly dynamic drive technology, sensors, electronics and software. We serve our customers around the globe at 10 locations on three continents, with the objective to make mobility, industrial assets, health care and the agricultural sector more efficient and safer with our innovations.

Since 2019, the ETO GRUPPE has consistently expanded its focus to include topics such as hydrogen technology, electric vehicles, connected driving, autonomization, and intelligent transport infrastructure. In addition, ETO offers new products and services based on digital technologies. In the field of digitization and Web3 communications, we set global standards as a foundation-led company with tamper-proof, data-sovereign business processes.

With our innovative and dynamic solutions. The ETO GRUPPE will keep people moving and our planet worth living on.

## Pioneer of a revolutionary technology

The ETO GRUPPE performs cutting-edge research with smart materials based on magnetic shape memory alloys. We are world leaders in this field and have developed the MAGNETOSHAPE® smart material ready-to-market. The damper version of our electrical stoppers is the world's first series product ever to use this revolutionary technology.



## Contents

- 4 | Overview of the stopper family and accessories
- 5 | Key customer benefits
- 6 | Energy cost savings
- 7 | CO<sub>2</sub> reduction
- 8 | Installation and maintenance costs
- 9 | Flexibility in planning
- 10 | Low noise level and short switching times
- 11 | Suitable for cleanrooms and low temperatures
- 12 | MAGNETOSHAPE®-Technology
- 13 | World's first MSM damper
- 14 | Damping process
- 15 | Technical data MSM damping

## The perfect solution for weights up to 30 kg

ETO offers you five electrical stoppers plus accessories for pallet weights up to 30 kilograms. They fit the most common TS1 and TS2+ transfer systems as well as systems compatible with them.

### The electrical stopper family from ETO



up to 4,8 kg

MAGNETOSHAPE® stopper with damper  
Article no. VEG4,8-TS1 and VEG4,8-TS2+



up to 8 kg

stopper without damper  
Article no. VEU8-TS1 and VEU8-TS2+



up to 30 kg

stopper without damper  
Article no. VEU30-TS2+



connector for power reduction  
Article no. LRS



power reduction cable (3 m)  
Article no. LRK3



power reduction cable (10 m)  
Article no. LRK10

## Why electrical stoppers from ETO?

Electrical stoppers have general advantages over pneumatic systems. However, the ETO stopper family is also superior to many other electrical stoppers.

Advantages compared to pneumatic stoppers	Advantages over electric stoppers from competitors
87 % savings in operating costs*	77 % savings in operating costs with lower acquisition costs *
easy to exchange – variants with and without damper**	easy to exchange – undamped against damped**
Low noise level in operation, reduction from approx. 78 db(A) to 65 db(A)	
fast cycle times possible due to short switching times (30 ms instead of approx. 200 ms)*	
suitable for clean installation	
works up to -40 °C with dry air (stoppers without damper)	

\* The basis of our calculation: Operation: 24 h / day; 280 days / year; electricity price: 0.23 € / kWh; cost / m<sup>3</sup> air at 6 bar: 0.03 €, WT weight: 3 kg; cycle time: 5 s, movement power / holding power electrical stoppers of other manufacturers: 48 W / 48 W and ETO stopper: 100 W / 9 W, activation per cycle: 2.5 s; leakage: 10 %, average maintenance costs at the ETO location Stockach per year u. m<sup>3</sup> air: 0.029 €.

\*\* In the same pallet weight range

## With ETO, your operating costs come down ...

In terms of acquisition cost alone, our stoppers are still head to head with pneumatic ones. But we reduce ongoing operating costs by 87 percent\*.

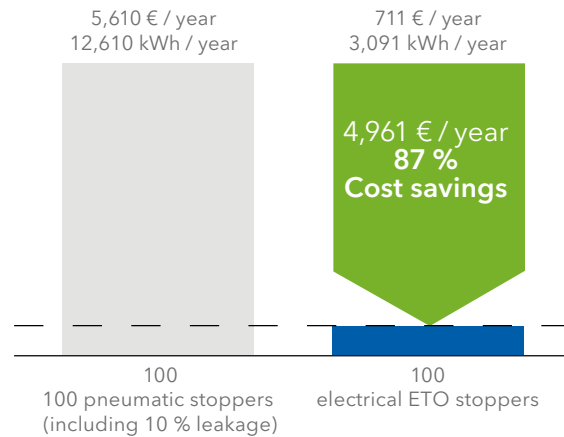

ETO is also best choice when compared to electrical stoppers from other manufacturers. Our products are more cost-effective and save 77 percent\* of the operating costs.

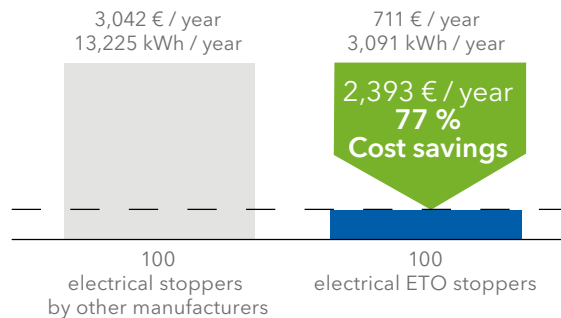

## ... and improve your production's carbon footprint!

An operating cost saving of 77 percent\*\* corresponds to an annual saving of 4.26 tons of CO<sub>2</sub>. To give an example: One ton of CO<sub>2</sub> could fill 6,000 medium-sized trash bags or a single-family home from basement to roof.\*\*\* The bottom line is that this saving equates to further savings in environmental cost. The German Federal Environment Agency puts the social cost per ton of carbon dioxide at 201.00 € for 2021.\*\*\* At 4.26 tons saved, that's 856.26 € per year - with just 100 ETO stoppers!

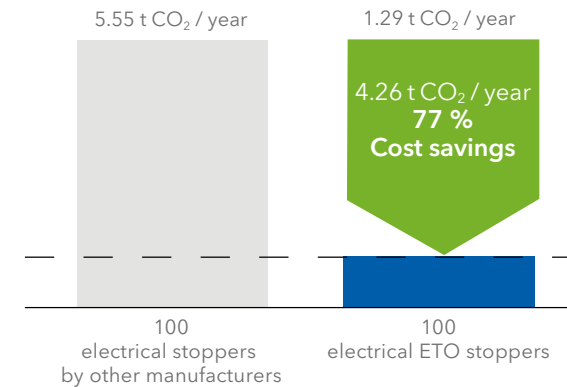

\* The basis of our calculation: Operation: 24 h / day; 280 days / year; electricity price: 0.23 € / kWh; cost / m<sup>3</sup> air at 6 bar: 0.03 €, WT weight: 3 kg; cycle time: 5 s, movement power / holding power electrical stoppers of other manufacturers: 48 W / 48 W and ETO stoppers: 100 W / 9 W, activation per cycle: 2.5 s; leakage: 10 %, average maintenance costs at the ETO location Stockach per year and m<sup>3</sup> air: 0.029 €.

\*\* In comparison with electrical stoppers of other manufacturers



\*\*\* See <https://www.umweltbundesamt.de/daten/umwelt-wirtschaft/gesellschaftliche-kosten-von-umweltbelastungen>

## Unbeatable in terms of assembly and maintenance

In terms of acquisition or system costs, electric ETO stoppers are on a par with pneumatic stoppers. However, we are clearly in the lead in terms of assembly and maintenance.

This is because the time-consuming installation and expensive maintenance of a pneumatic system is completely eliminated for our stoppers, including the required compressors, hoses and wiring. Performance losses due to leaks in the pneumatic system belong to the past.

When compared with electrical stoppers from other manufacturers there can be no other choice but ETO: **Less expensive to purchase and operate!**

	Components	Additional components
Pneumatic stopper system		<ul style="list-style-type: none"> <li>PLC</li> <li>⚡</li> <li>Pneumatic</li> </ul>
Electrical stopper system		<ul style="list-style-type: none"> <li>PLC</li> <li>⚡</li> </ul>

## Replace undamped with damped - in no time at all!

Another special feature of the ETO stoppers with and without dampers is that, despite their compact dimensions, they both require the same installation space. This means that they can easily be exchanged for another at any time in the same pallet weight class.

For you, this means maximum flexibility – right from the planning stage. If a stopper with damper is needed at a later point instead of one without a damper: Simply swap it! With ETO it's possible.

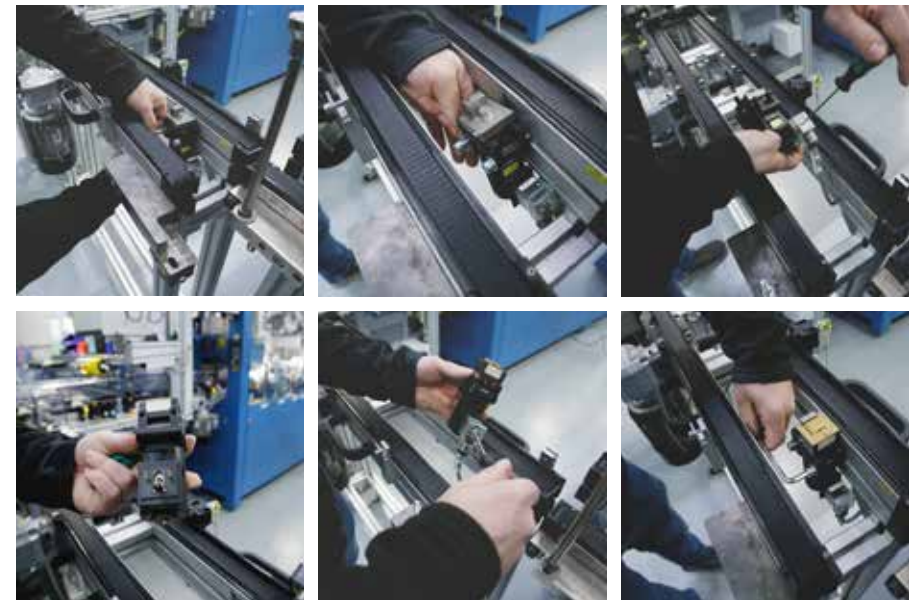

Replacing an undamped ETO stopper with a damped one is a breeze (observe the maximum total pallet mass when using stoppers with dampers).

## Extremely quiet in operation and at the same time extremely fast

With < 65 db (A), electrical stoppers from ETO are extremely quiet in operation. Compared to pneumatic stoppers, this corresponds to a reduction in noise level of more than 400 percent.

The switching times of the ETO stoppers are extremely short at 30 ms compared to 200 ms for pneumatic stoppers and therefore also enable short cycle times.\*



\* For a pallet weight of 3 kg

## The clean solution - also for your cleanroom production

A great advantage of electrical stoppers is the possibility to use them for clean assemblies in clean rooms as well. With pneumatic systems, there will always be air movements that cause dangerous dust turbulence. Electrical stoppers from ETO, on the other hand, may be used without any problems in clean rooms for clean assemblies.

## Pretty cool, these ETO stoppers

ETO stoppers operate reliably over a wide temperature range. In dry air, the range for the undamped stoppers extends from -40 °C to +40 °C. This means for you: You can even use our ETO stoppers in deep-freeze production or other low-temperature areas.



No functional impairment in dry air during test at -40 °C

## ETO's smart materials are ready for series

Alloys with magnetic shape memory (MSM) are ferromagnetic materials that generate force and motion under magnetic fields. The typically single-crystalline alloys made from nickel, manganese, and gallium, are able to generate 6 % strain under external loads at frequencies up to the low kilohertz range. This allows to implement drives or motion control systems, in which motion is generated by the material itself and tribological interfaces are avoided. Under the MAGNETOSHAPE® brand, the ETO GRUPPE is world leader since many years in fundamental research, production and application of these smart materials. The damped stopper is the world's first series product based on this unique technology.



MAGNETOSHAPE®-material

## The world's first MSM damper

The innovative MSM damper D1000 is a central component of our two damped MAGNETOSHAPE® stoppers VEG-TS1 and VEG-TS2+. The D1000 minimizes the impact force of the workpiece pallet during stopping. The pallet is gently brought to a halt and held in a defined position after the damping process. ETO has implemented the damping function for the first time using a magnetic shape memory material. The MSM component is compressed in the magnetic field of permanent magnets. The internal friction of the material dissipates the kinetic energy of the pallet and prevents its oscillation in front of the damper. Immediate extension of the MSM element after the damping process ensures exact positioning of the pallet at a defined stop position.

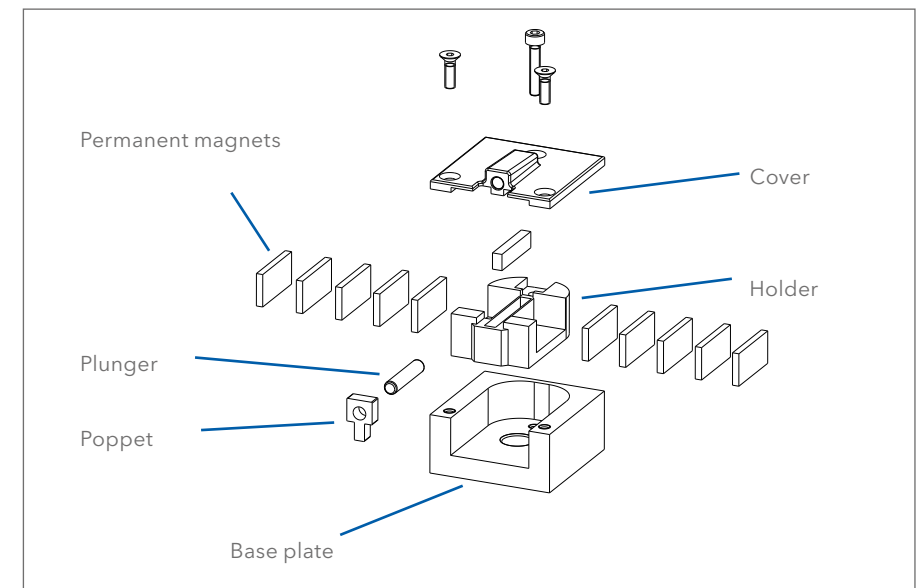



## The technical side of the MSM damping process

One feature of the MSM damper is a characteristic force-displacement curve that is independent of speed. This characteristic curve describes the available damping energy of the damper. The combination of damper, pallet weight and belt speed is designed to customer specifications to ensure that the damper is fully compressed but that a hard stop is ruled out. The force during extension guarantees that the pallet stops at a defined position after each damping process. The damping energy is the difference between the braking energy absorbed during retraction and the stored energy for extension. The MSM material of the solid-state damper allows a strain of 5 percent. With a MSM element length of 20 mm, the damper achieves a damping travel of 1 mm.

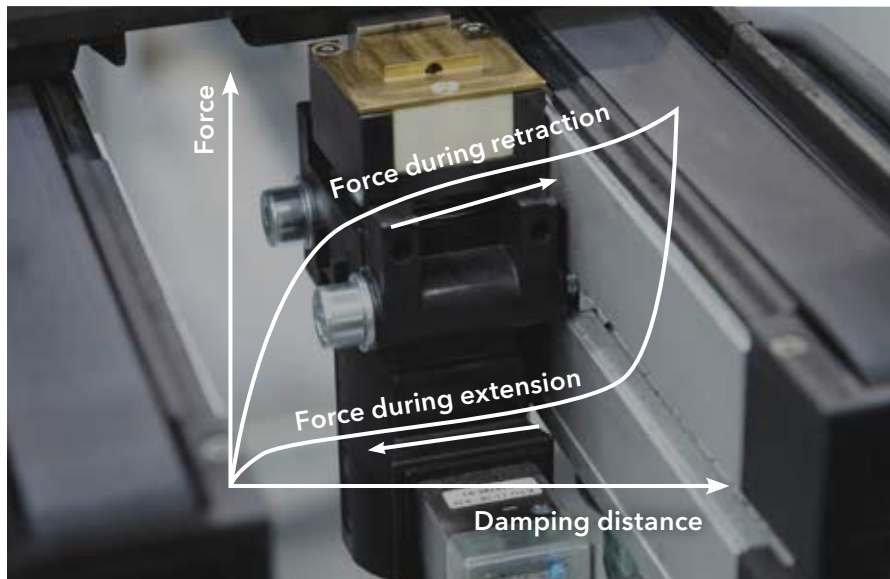

## Applications and variants

Allowed total pallet weights (= pallet + workpiece):

Belt speed	Pallet weight
6 m/min	up to max. 4.8 kg
9 m/min	up to max. 2.5 kg
12 m/min	up to max. 1.5 kg
15 m/min	up to max. 1.0 kg
18 m/min	up to max. 0.8 kg

If the total weights are higher than those given in the table above, the pallet is partially damped and moves against a plastic stop at the end of the damping process, which may result in higher impact forces.

## Technical data and MSM damping process

Technical data	
Nominal damping stroke	1 mm
Operating temperature range	0 °C to 40 °C ambient temperature
Materials	Galvanized steel housing, stainless steel stop and stainless steel guide, plastic housing parts
Vacuum operation	possible
Maintenance	Maintenance-free up to at least 10 million damping cycles or 12,500 operating hours at an average cycle time of 4.5 sec.



**ETO** GRUPPE  
MOTION TECHNOLOGIES



**ETO GRUPPE**

Hardtring 8, 78333 Stockach, Germany

Phone: +49 7771 809-0

Email: [info@etogruppe.com](mailto:info@etogruppe.com)

[www.etogruppe.com](http://www.etogruppe.com)

